

6 Station All Access Gym Fit For Parks

The Fit for Parks product range has been developed in conjunction with exercise physiologists to deliver a comprehensive community fitness solution. Fit for Parks Product Ranges It covers the three key elements of fitness training including cardio, strength and mobility. All equipment includes detailed yet easy to follow instructional signage incorporating QR codes that link to demonstration videos that can be accessed by users on site.

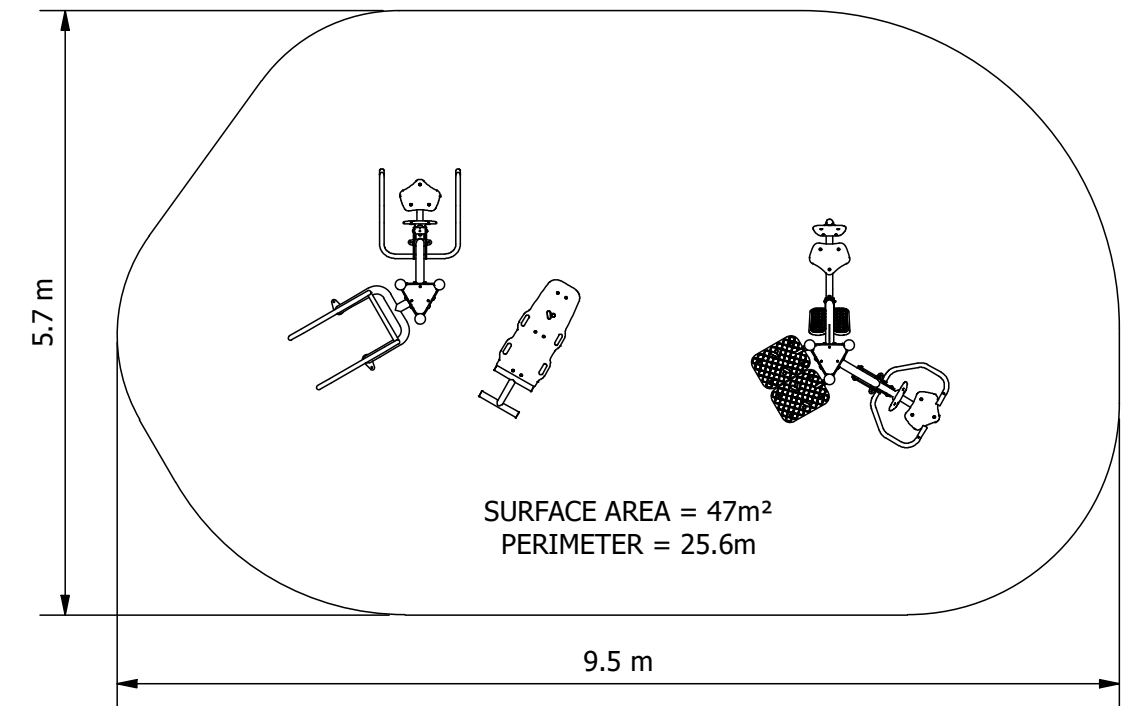

Product Code: DFP-0061

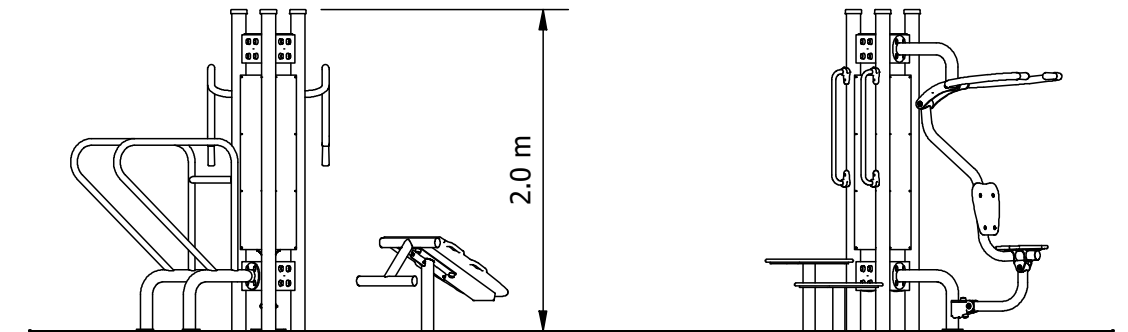

Required Space
5.7m x 9.5m



Area
47.0m²



Age Group
12+



Max FHoF
860mm



Equipment Height
2000mm

