

4 Station Challenge Fitness Extra

The Fitness Extra range was designed drawing on popular exercise 'systems' which many fitness enthusiasts are accustomed to. These include 'CrossFit' and 'TRX Suspension Training'. The range has been engineered for extreme durability and safety. All equipment includes detailed yet easy to follow instructional signage incorporating QR codes that link to demonstration videos that can be accessed by users on site.

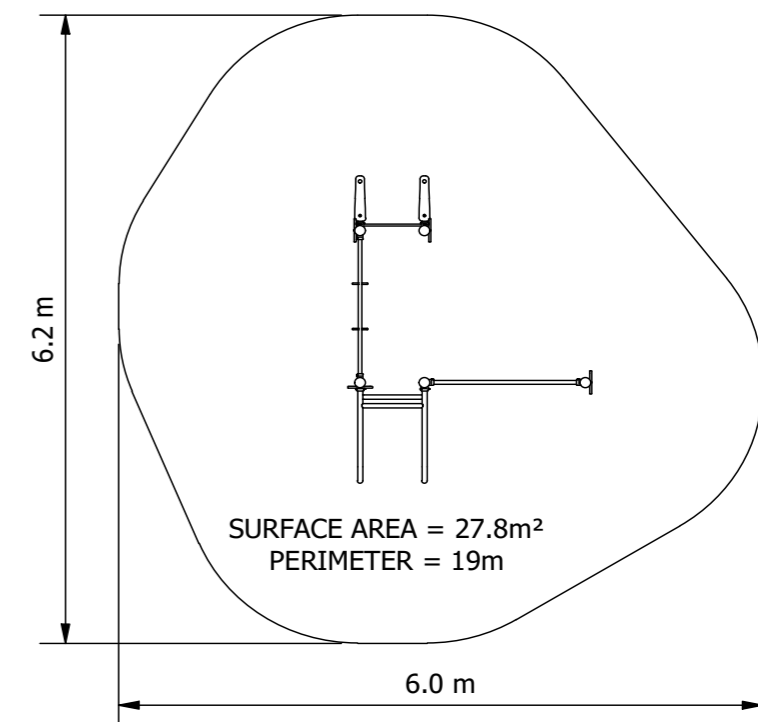

Product Code: DFX-0077

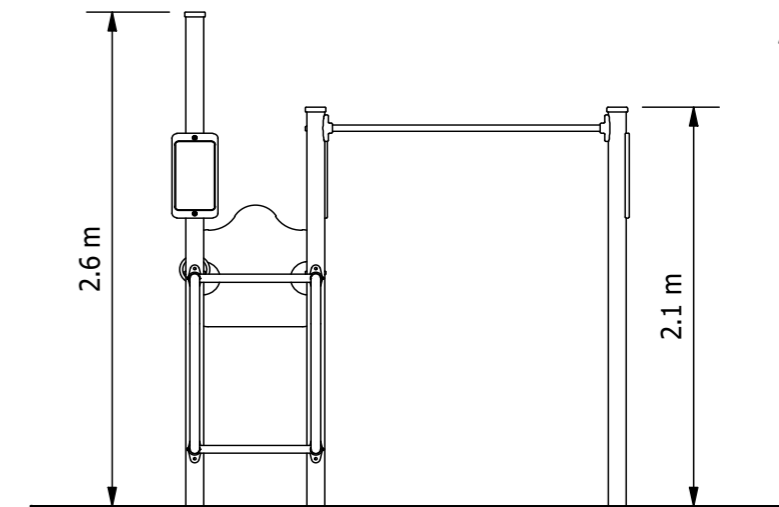

Required Space
6.0m x 6.2m



Area
27.8m²



Age Group
12+



Max FHoF
990mm



Equipment Height
2600mm